



# 60mA, SOT23 Inverting Charge Pump with Shutdown

MAX1697

## General Description

The MAX1697 ultra-small, monolithic, CMOS charge-pump voltage inverter accepts an input voltage ranging from +1.25V to +5.5V. This device features an ultra-low 12Ω output resistance, permitting loads of up to 60mA with maximum efficiency. The MAX1697 is available with operating frequencies of 12kHz, 35kHz, 125kHz, or 250kHz, allowing optimization of supply current or external component size. Its small external components and micropower shutdown mode make this device ideal for both battery-powered and board-level voltage conversion applications.

Oscillator control circuitry and four power MOSFET switches are included on-chip. Applications include generating a negative supply from a +5V or +3.3V logic supply to power analog circuitry. All versions come in a 6-pin SOT23 package and deliver 60mA.

For applications with lower current requirements, the MAX1719/MAX1720/MAX1721 are pin-compatible SOT23 charge pumps that supply up to 25mA.

## Applications

Negative Supply from +5V or +3.3V Logic Supplies  
 Small LCD Panels  
 GaAsFET Bias Supplies  
 Handy-Terminals, PDAs  
 Battery-Operated Equipment

## Typical Operating Circuit

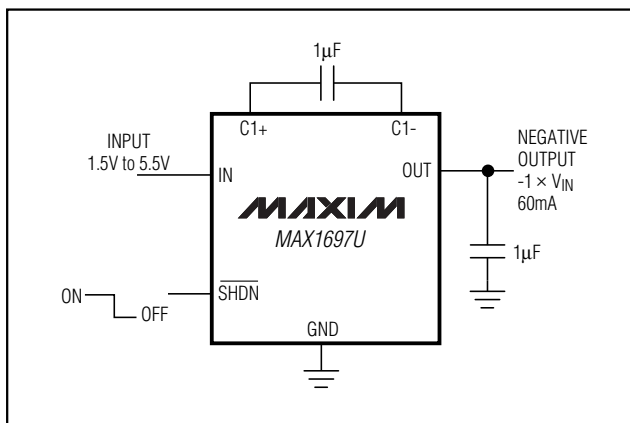

## Features

- ◆ 60mA Output Current
- ◆ Low 12Ω Output Resistance
- ◆ 150µA Supply Current (MAX1697R)
- ◆ Requires Only Two 1µF Capacitors (MAX1697U)
- ◆ Start-Up Current Limited
- ◆ +1.25V to +5.5V Input Voltage Range
- ◆ 0.1µA Logic-Controlled Shutdown
- ◆ Slew-Rate Limited to Reduce EMI
- ◆ 6-Pin SOT23 Package

## Ordering Information

PART	TEMP. RANGE	PIN-PACKAGE
MAX1697_EUT-T	-40°C to +85°C	6 SOT23-6

**Note 1:** The MAX1697 requires special solder temperature profile described in the Absolute Maximum Ratings section.

**Note 2:** The MAX1697 is available with four different operating frequencies. Choose the desired frequency from the table below and insert the suffix in the blank above to complete the part number.

PART NO. SUFFIX	FREQUENCY (kHz)	TOP MARK
R	12	AABV
S	35	AABW
T	125	AABX
U	250	AABY

## Pin Configuration

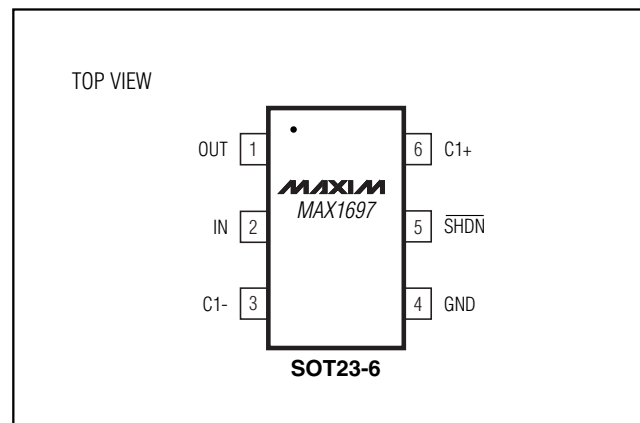

# 60mA, SOT23 Inverting Charge Pump with Shutdown

## ABSOLUTE MAXIMUM RATINGS

IN to GND	-0.3V to +6V	Continuous Power Dissipation ( $T_A = +70^\circ\text{C}$ )
C1+, $\overline{\text{SHDN}}$ to GND	-0.3V to ( $V_{\text{IN}} + 0.3\text{V}$ )	6-Pin SOT23 (derate 14mW/ $^\circ\text{C}$ above $+70^\circ\text{C}$ ) (Note 3)...1.1W
C1- to GND	( $V_{\text{OUT}} - 0.3\text{V}$ ) to +0.3V	Operating Temperature Range
OUT to GND	+0.3V to -6V	-40 $^\circ\text{C}$ to +85 $^\circ\text{C}$
OUT Output Current	90mA	Junction Temperature
OUT Short-Circuit to GND	Indefinite	+150 $^\circ\text{C}$
		Storage Temperature Range
		-65 $^\circ\text{C}$ to +150 $^\circ\text{C}$
		Lead Temperature
		(Note 4)

**Note 3:** Thermal properties are specified with product mounted on the PC board with one square-inch of copper area and still air.

**Note 4:** This device is constructed using a unique set of packaging techniques that impose a limit on the thermal profile the device can be exposed to during board level solder attach and rework. Maxim recommends the use of the solder profiles recommended in the industry standard specification, JEDEC 020A, paragraph 7.6, Table 3 for IR/VPR and Convection reflow processes. Preheating, per this standard, is required. Hand or wave soldering is not recommended.

Stresses beyond those listed under "Absolute Maximum Ratings" may cause permanent damage to the device. These are stress ratings only, and functional operation of the device at these or any other conditions beyond those indicated in the operational sections of the specifications is not implied. Exposure to absolute maximum rating conditions for extended periods may affect device reliability.

## ELECTRICAL CHARACTERISTICS

(Circuit of Figure 1, capacitors from Table 2,  $V_{\text{IN}} = +5\text{V}$ ,  $\overline{\text{SHDN}} = \text{IN}$ ,  $T_A = 0^\circ\text{C}$  to  $+85^\circ\text{C}$ , unless otherwise noted. Typical values are at  $T_A = +25^\circ\text{C}$ .)

PARAMETER	CONDITIONS	MIN	TYP	MAX	UNITS	
Supply Voltage Range	MAX1697R/S, $R_L = 5\text{k}\Omega$	$T_A = +25^\circ\text{C}$	1.25	5.5	V	
		$T_A = 0^\circ\text{C}$ to $+85^\circ\text{C}$	1.5	5.5		
	MAX1697T/U, $R_L = 5\text{k}\Omega$	$T_A = +25^\circ\text{C}$	1.4	5.5		
		$T_A = 0^\circ\text{C}$ to $+85^\circ\text{C}$	1.5	5.5		
Quiescent Supply Current	$T_A = +25^\circ\text{C}$	MAX1697R	150	300	$\mu\text{A}$	
		MAX1697S	350	650		
		MAX1697T	950	1700		
		MAX1697U	1800	3400		
Shutdown Supply Current	$\overline{\text{SHDN}} = \text{GND}$	$T_A = +25^\circ\text{C}$	0.002	1	$\mu\text{A}$	
		$T_A = +85^\circ\text{C}$	0.03			
Short-Circuit Current	Output shorted to ground, $T_A = +25^\circ\text{C}$		170		mA	
Oscillator Frequency	$T_A = +25^\circ\text{C}$	MAX1697R	7	12	17	kHz
		MAX1697S	20	35	50	
		MAX1697T	70	125	180	
		MAX1697U	140	250	360	
Voltage Conversion Efficiency	$I_{\text{OUT}} = 0$ , $T_A = +25^\circ\text{C}$	99	99.9		%	
Output Resistance (Note 5)	$I_{\text{OUT}} = 60\text{mA}$	$T_A = +25^\circ\text{C}$		12	25	$\Omega$
		$T_A = 0^\circ\text{C}$ to $+85^\circ\text{C}$			33	
OUT to GND Shutdown Resistance	$\overline{\text{SHDN}} = \text{GND}$ , OUT is internally pulled to GND in shutdown		3	8	$\Omega$	
$\overline{\text{SHDN}}$ Input Logic High	$2.5\text{V} \leq V_{\text{IN}} \leq 5.5\text{V}$	2.0			V	
	$V_{\text{IN(MIN)}} \leq V_{\text{IN}} \leq 2.5\text{V}$	$V_{\text{IN}} - 0.2$				
$\overline{\text{SHDN}}$ Input Logic Low	$2.5\text{V} \leq V_{\text{IN}} \leq 5.5\text{V}$			0.6	V	
	$V_{\text{IN(MIN)}} \leq V_{\text{IN}} \leq 2.5\text{V}$			0.2		
$\overline{\text{SHDN}}$ Bias Current	$\overline{\text{SHDN}} = \text{GND}$ or IN	$T_A = +25^\circ\text{C}$	-100	0.05	+100	nA
		$T_A = +85^\circ\text{C}$		10		

# 60mA, SOT23 Inverting Charge Pump with Shutdown

MAX1697

## ELECTRICAL CHARACTERISTICS (continued)

(Circuit of Figure 1, capacitors from Table 2,  $V_{IN} = +5V$ ,  $\overline{SHDN} = IN$ ,  $T_A = 0^{\circ}C$  to  $+85^{\circ}C$ , unless otherwise noted. Typical values are at  $T_A = +25^{\circ}C$ .)

PARAMETER	CONDITIONS	MIN	TYP	MAX	UNITS
Wake-Up Time from Shutdown	$I_{OUT} = 15mA$	MAX1697R	1200		$\mu s$
		MAX1697S	600		
		MAX1697T	100		
		MAX1697U	70		
<b>THERMAL SHUTDOWN</b>					
Trip Temperature	Temperature increasing		150		$^{\circ}C$
Hysteresis			15		$^{\circ}C$

## ELECTRICAL CHARACTERISTICS

(Circuit of Figure 1, capacitors from Table 2,  $V_{IN} = +5V$ ,  $\overline{SHDN} = IN$ ,  $T_A = -40^{\circ}C$  to  $+85^{\circ}C$ , unless otherwise noted.) (Note 6)

PARAMETER	CONDITIONS	MIN	MAX	UNITS	
Supply Voltage Range	$R_L = 5k\Omega$	MAX1697R/S	1.5	5.5	V
		MAX1697T/U	1.6	5.5	
Output Current	Continuous, long-term		60	$mA_{RMS}$	
Quiescent Current	MAX1697R		350	$\mu A$	
	MAX1697S		750		
	MAX1697T		1800		
	MAX1697U		3600		
Oscillator Frequency	MAX1697R	6	21	kHz	
	MAX1697S	16	60		
	MAX1697T	60	200		
	MAX1697U	120	400		
Output Resistance (Note 5)	$I_{OUT} = 60mA$		33	$\Omega$	
OUT to GND Shutdown Resistance	$\overline{SHDN} = GND$ , OUT is internally pulled to GND in shutdown		8	$\Omega$	
$\overline{SHDN}$ Input Logic High	$2.5V \leq V_{IN} \leq 5.5V$	2.1		V	
	$V_{IN(MIN)} \leq V_{IN} \leq 2.5V$	$V_{IN} - 0.2$			
$\overline{SHDN}$ Input Logic Low	$2.5V \leq V_{IN} \leq 5.5V$		0.6	V	
	$V_{IN(MIN)} \leq V_{IN} \leq 2.5V$		0.2		

**Note 5:** Output resistance is guaranteed with capacitor ESR of  $0.3\Omega$  or less.

**Note 6:** All specifications from  $-40^{\circ}C$  to  $+85^{\circ}C$  are guaranteed by design, not production tested.

# 60mA, SOT23 Inverting Charge Pump with Shutdown

## Typical Operating Characteristics

(Circuit of Figure 1, capacitors from Table 2,  $V_{IN} = +5V$ ,  $\overline{SHDN} = IN$ ,  $T_A = +25^\circ C$ , unless otherwise noted.)

**MAX1697R**  
OUTPUT VOLTAGE  
vs. OUTPUT CURRENT

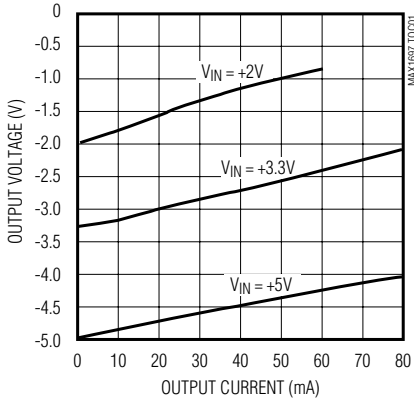

**MAX1697S**  
OUTPUT VOLTAGE  
vs. OUTPUT CURRENT

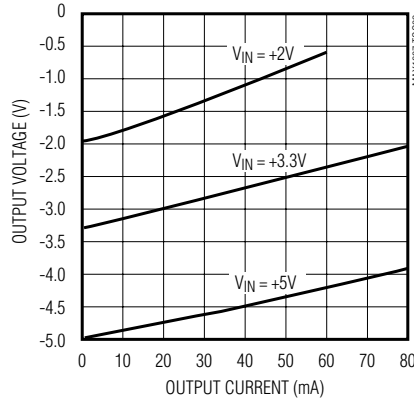

**MAX1697T**  
OUTPUT VOLTAGE  
vs. OUTPUT CURRENT

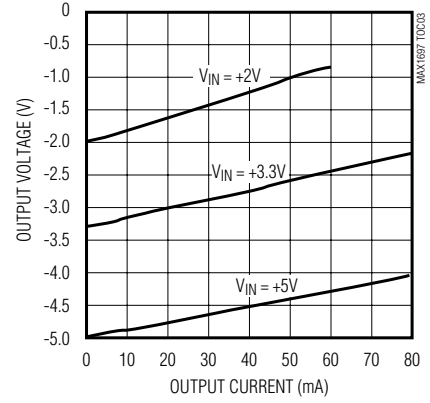

**MAX1697U**  
OUTPUT VOLTAGE  
vs. OUTPUT CURRENT

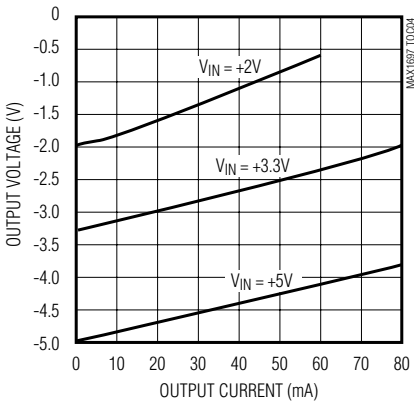

**MAX1697R**  
EFFICIENCY vs. OUTPUT CURRENT

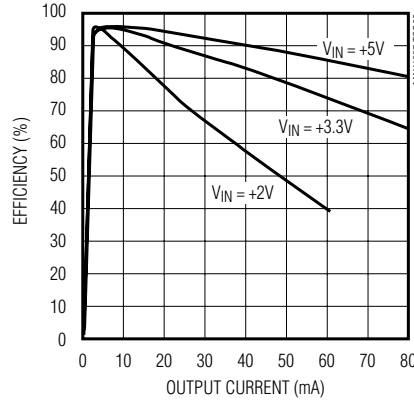

**MAX1697S**  
EFFICIENCY vs. OUTPUT CURRENT

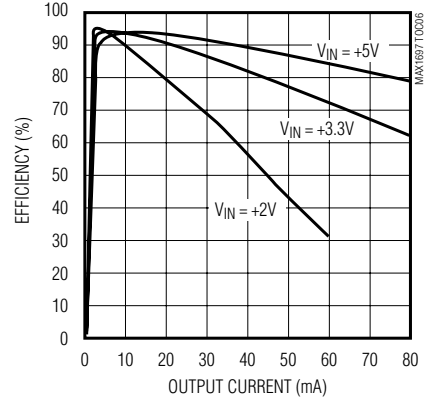

**MAX1697T**  
EFFICIENCY vs. OUTPUT CURRENT

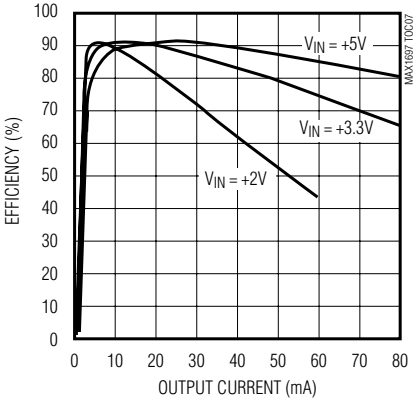

**MAX1697U**  
EFFICIENCY vs. OUTPUT CURRENT

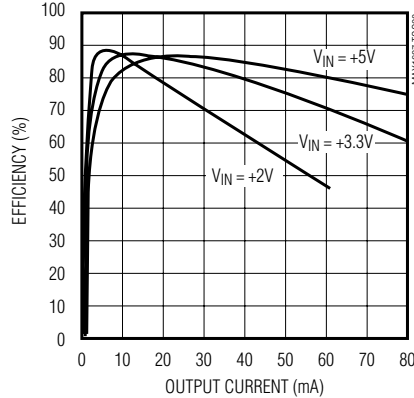

**MAX1697R/S/T/U**  
OUTPUT IMPEDANCE vs. INPUT VOLTAGE

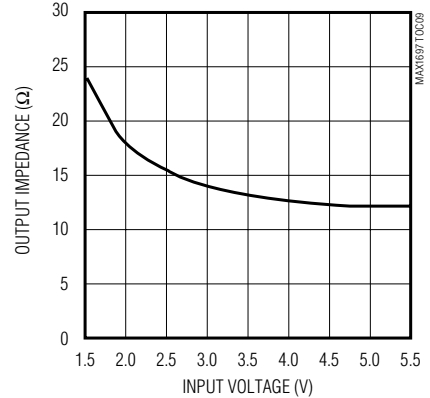

# 60mA, SOT23 Inverting Charge Pump with Shutdown

MAX1697

## Typical Operating Characteristics (continued)

(Circuit of Figure 1, capacitors from Table 2,  $V_{IN} = +5V$ ,  $\overline{SHDN} = IN$ ,  $T_A = +25^\circ C$ , unless otherwise noted.)

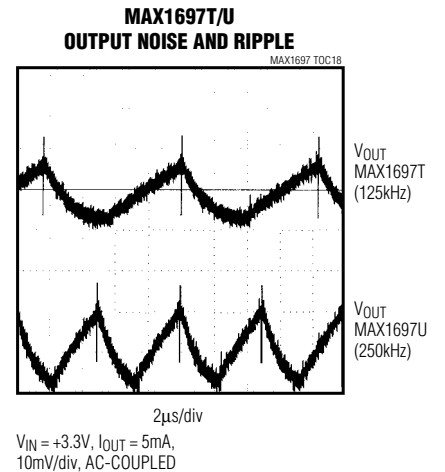
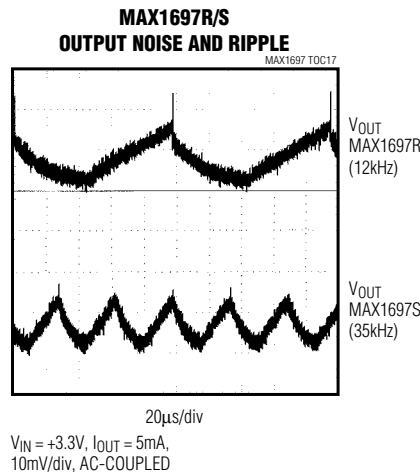
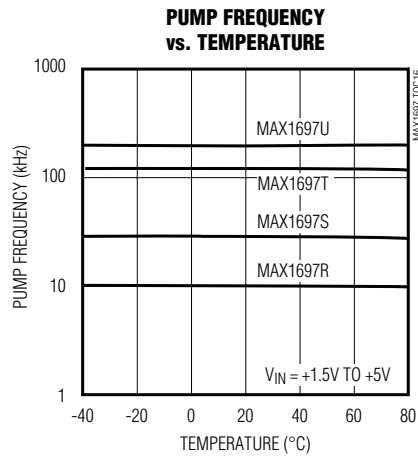
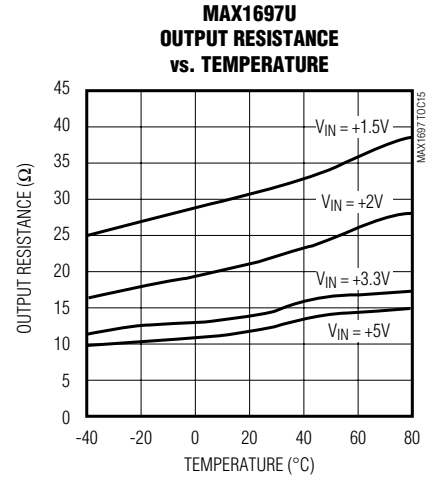
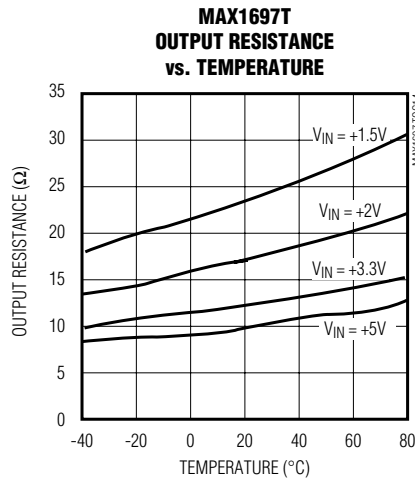
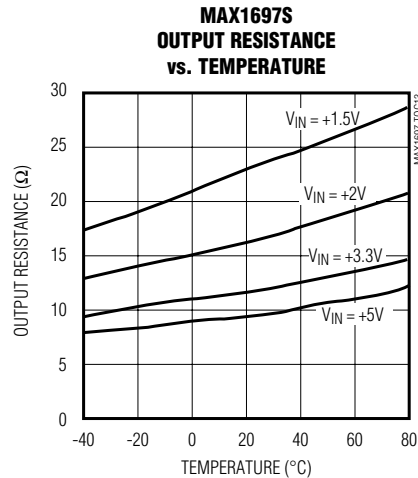
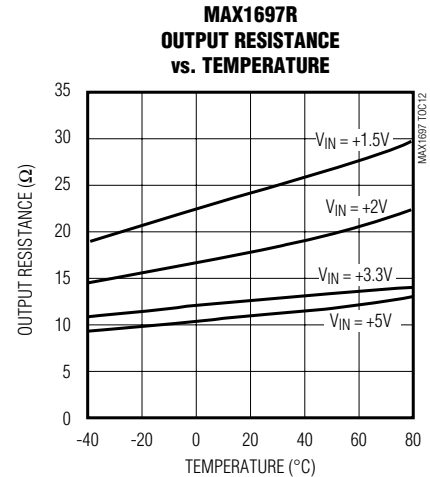
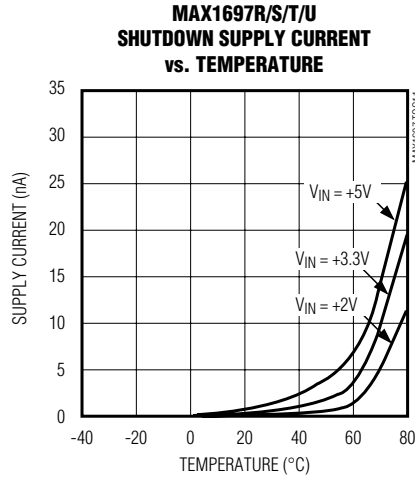
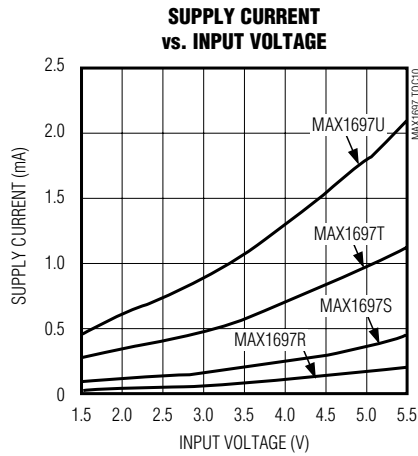

# 60mA, SOT23 Inverting Charge Pump with Shutdown

## Typical Operating Characteristics (continued)

(Circuit of Figure 1, capacitors from Table 2,  $V_{IN} = +5V$ ,  $SHDN = IN$ ,  $T_A = +25^\circ C$ , unless otherwise noted.)

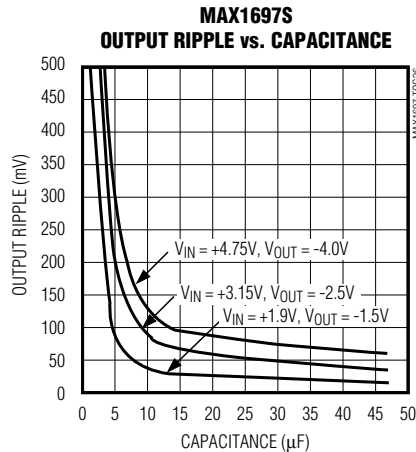
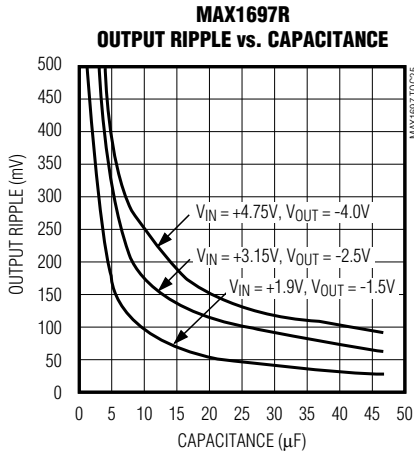
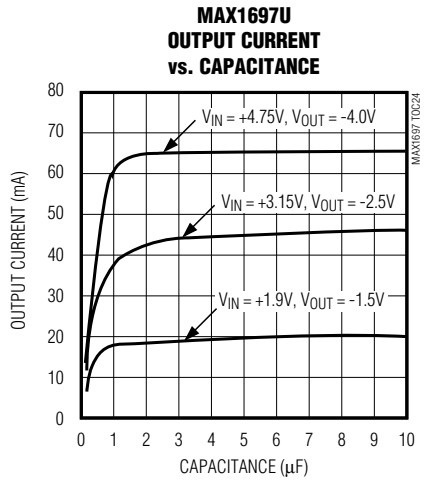
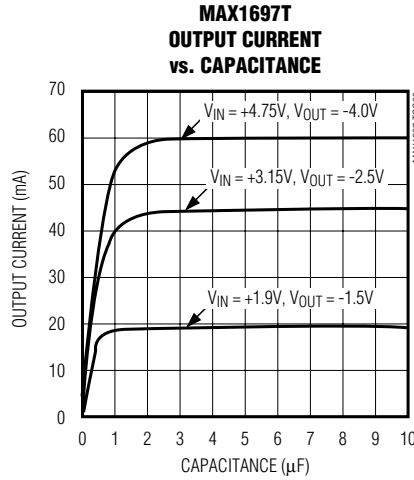
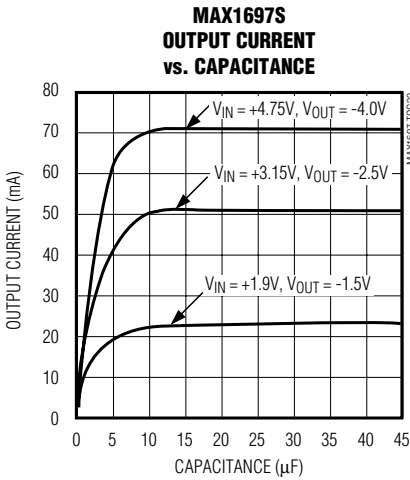
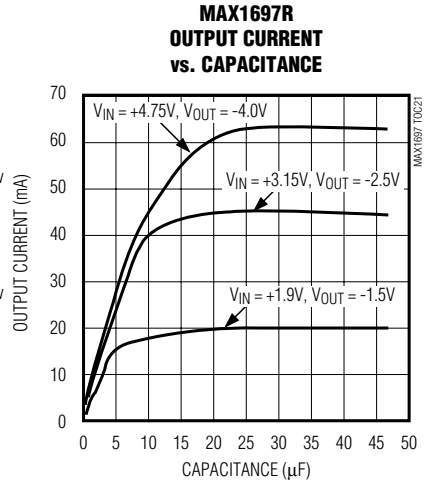
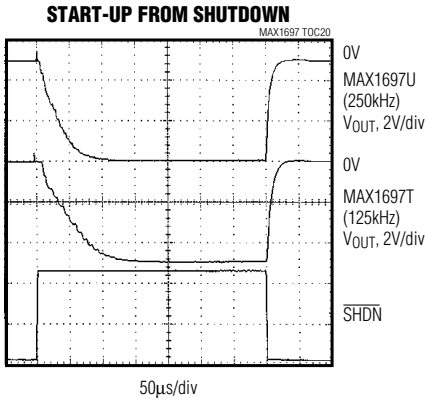
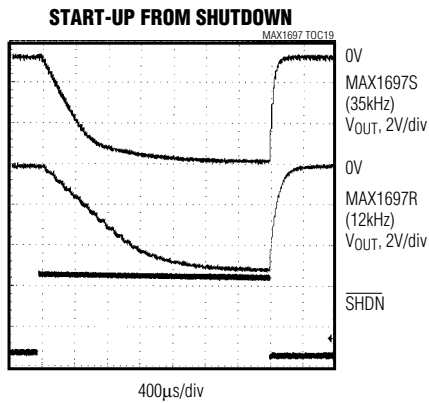

# 60mA, SOT23 Inverting Charge Pump with Shutdown

MAX1697

## Typical Operating Characteristics (continued)

(Circuit of Figure 1, capacitors from Table 2,  $V_{IN} = +5V$ ,  $\overline{SHDN} = IN$ ,  $T_A = +25^\circ C$ , unless otherwise noted.)

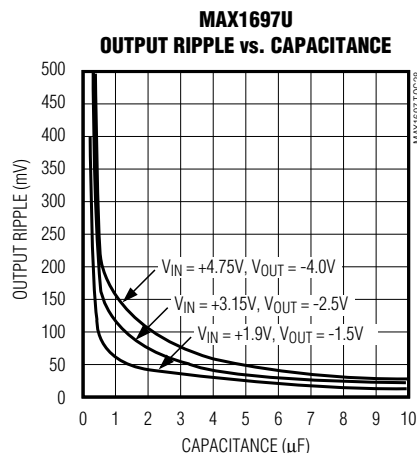
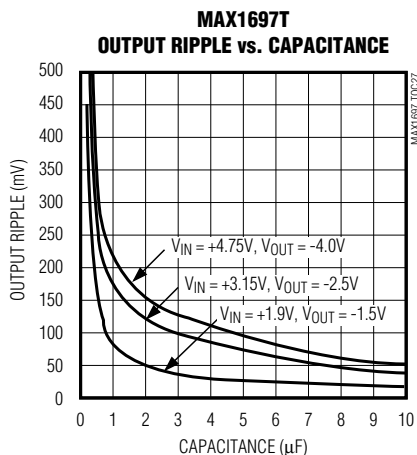

## Pin Description

PIN	NAME	FUNCTION
1	OUT	Inverting Charge-Pump Output
2	IN	Power-Supply Voltage Input. Input range is 1.5V to 5.5V.
3	C1-	Negative Terminal of the Flying Capacitor
4	GND	Ground
5	$\overline{SHDN}$	Shutdown Input. Drive this pin high for normal operation; drive it low for shutdown mode. OUT is actively pulled to ground during shutdown.
6	C1+	Positive Terminal of the Flying Capacitor

## Detailed Description

The MAX1697 capacitive charge pumps invert the voltage applied to their input. For highest performance, use low equivalent series resistance (ESR) capacitors (e.g., ceramic).

During the first half-cycle, switches S2 and S4 open, switches S1 and S3 close, and capacitor C1 charges to the voltage at IN (Figure 2). During the second half-cycle, S1 and S3 open, S2 and S4 close, and C1 is level shifted downward by  $V_{IN}$  volts. This connects C1 in parallel with the reservoir capacitor C2. If the voltage across

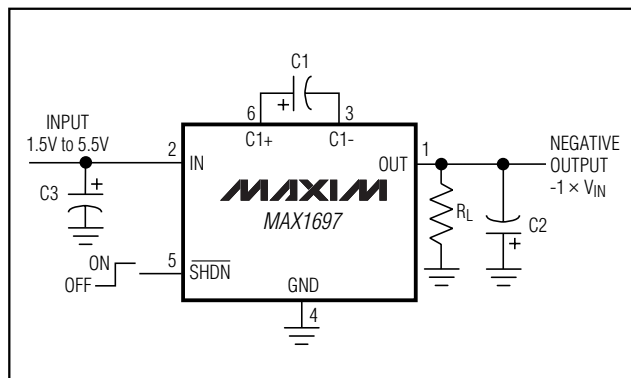

Figure 1. Typical Application Circuit

C2 is smaller than the voltage across C1, charge flows from C1 to C2 until the voltage across C2 reaches  $-V_{IN}$ . The actual voltage at the output is more positive than  $-V_{IN}$ , since switches S1–S4 have resistance and the load drains charge from C2.

## Efficiency Considerations

The efficiency of the MAX1697 is dominated by its quiescent supply current ( $I_Q$ ) at low output current and by its output impedance ( $R_{OUT}$ ) at higher output current; it is given by:

$$\eta \cong \frac{I_{OUT}}{I_{OUT} + I_Q} \left( 1 - \frac{I_{OUT} \times R_{OUT}}{V_{IN}} \right)$$

# 60mA, SOT23 Inverting Charge Pump with Shutdown

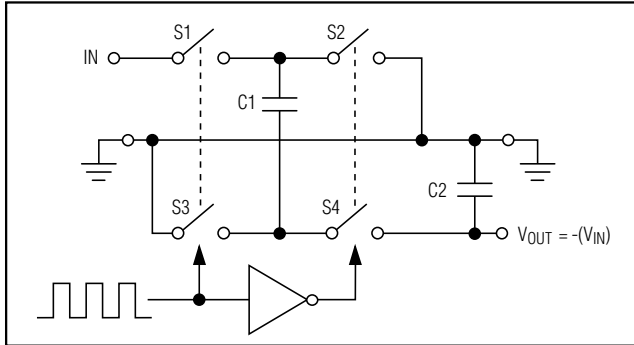

Figure 2. Ideal Voltage Inverter

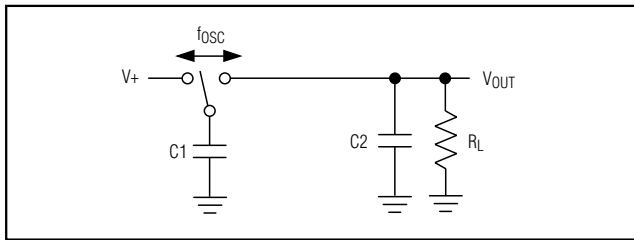

Figure 3a. Switched-Capacitor Model

where the output impedance is roughly approximated by:

$$R_{OUT} \cong \frac{1}{(f_{OSC}) \times C1} + 2R_{SW} + 4ESR_{C1} + ESR_{C2}$$

The first term is the effective resistance of an ideal switched-capacitor circuit (Figures 3a and 3b), and  $R_{SW}$  is the sum of the charge pump's internal switch resistances (typically  $4\Omega$  to  $5\Omega$  at  $V_{IN} = +5V$ ). The typical output impedance is more accurately determined from the *Typical Operating Characteristics*.

### Current Limit

The MAX1697 limits its input current upon start-up to 170mA (typ). This prevents low-current or higher output impedance input supplies (such as alkaline cells) from being overloaded when power is applied or when the device awakes from shutdown.

### Shutdown

The MAX1697 has a logic-controlled shutdown input. Driving  $\overline{SHDN}$  low places the device in a low-power shutdown mode. The charge-pump switching halts, supply current is reduced to 2nA, and OUT is actively pulled to ground through a  $3\Omega$  resistance.

Driving  $\overline{SHDN}$  high will restart the charge pump. The switching frequency and capacitor values determine how soon the device will reach 90% of the input voltage.

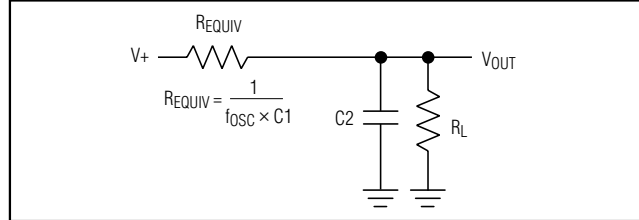

Figure 3b. Equivalent Circuit

### Thermal Shutdown

The MAX1697 has a thermal shutdown mode for additional protection against fault conditions. When the temperature of the die exceeds  $+150^{\circ}\text{C}$ , the internal clock stops, suspending the device's operation. The MAX1697 resumes operation when the die temperature falls  $15^{\circ}\text{C}$ . This prevents the device from rapidly oscillating around the temperature trip point.

## Applications Information

### Capacitor Selection

The charge-pump output resistance is a function of the ESR of C1 and C2. To maintain the lowest output resistance, use capacitors with low ESR. (See Table 1 for a list of recommended manufacturers.) Tables 2 and 3 suggest capacitor values for minimizing output resistance or capacitor size.

### Flying Capacitor (C1)

Increasing the flying capacitor's value reduces the output resistance. Above a certain point, increasing C1's capacitance has negligible effect because the output resistance is then dominated by internal switch resistance and capacitor ESR.

### Output Capacitor (C2)

Increasing the output capacitor's value reduces the output ripple voltage. Decreasing its ESR reduces both output resistance and ripple. Lower capacitance values can be used with light loads if higher output ripple can be tolerated. Use the following equation to calculate the peak-to-peak ripple:

$$V_{RIPPLE} = \frac{I_{OUT}}{2(f_{OSC})C2} + 2 \times I_{OUT} \times ESR_{C2}$$

### Input Bypass Capacitor (C3)

If necessary, bypass the incoming supply to reduce its AC impedance and the impact of the MAX1697's switching noise. A bypass capacitor with a value equal to that of C1 is recommended.



# 60mA, SOT23 Inverting Charge Pump with Shutdown

## Voltage Inverter

The most common application for these devices is a charge-pump voltage inverter (Figure 1). This application requires only two external components—capacitors C1 and C2—plus a bypass capacitor, if necessary. Refer to the *Capacitor Selection* section for suggested capacitor types.

## Cascading Devices

Two devices can be cascaded to produce an even larger negative voltage (Figure 4). The unloaded output voltage is normally  $-2 \times V_{IN}$ , but this is reduced slightly by the output resistance of the first device multiplied by the quiescent current of the second. When cascading more than two devices, the output resistance rises dramatically. For applications requiring larger negative voltages, see the MAX865 and MAX868 data sheets.

## Paralleling Devices

Paralleling multiple MAX1697s reduces the output resistance. Each device requires its own pump capacitor (C1), but the reservoir capacitor (C2) serves all devices (Figure 5). Increase C2's value by a factor of  $n$ , where  $n$  is the number of parallel devices. Figure 5 shows the equation for calculating output resistance.

## Combined Doubler/Inverter

In the circuit of Figure 6, capacitors C1 and C2 form the inverter, while C3 and C4 form the doubler. C1 and C3 are the pump capacitors; C2 and C4 are the reservoir capacitors. Because both the inverter and doubler use part of the charge-pump circuit, loading either output causes both outputs to decline toward GND. Make sure the sum of the currents drawn from the two outputs does not exceed 60mA.

## Heavy Load Connected to a Positive Supply

Under heavy loads, where a higher supply is sourcing current into OUT, the OUT supply must not be pulled above ground. Applications that sink heavy current into OUT require a Schottky diode (1N5817) between GND and OUT, with the anode connected to OUT (Figure 7).

## Layout and Grounding

Good layout is important, primarily for good noise performance. To ensure good layout, mount all components as close together as possible, keep traces short to minimize parasitic inductance and capacitance, and use a ground plane.

**Table 1. Low-ESR Capacitor Manufacturers**

PRODUCTION METHOD	MANUFACTURER	SERIES	PHONE	FAX
Surface-Mount Tantalum	AVX	TPS series	803-946-0690	803-626-3123
	Matsuo	267 series	714-969-2491	714-960-6492
	Sprague	593D, 595D series	603-224-1961	603-224-1430
Surface-Mount Ceramic	AVX	X7R	803-946-0690	803-626-3123
	Matsuo	X7R	714-969-2491	714-960-6492

**Table 2. Capacitor Selection to Minimize Output Resistance**

PART	FREQUENCY (kHz)	CAPACITOR ( $\mu$ F)	TYPICAL $R_{OUT}$ ( $\Omega$ )
MAX1697R	12	22	12
MAX1697S	35	6.8	12
MAX1697T	125	2.2	12
MAX1697U	250	1	12

**Table 3. Capacitor Selection to Minimize Capacitor Size**

PART	FREQUENCY (kHz)	CAPACITOR ( $\mu$ F)	TYPICAL $R_{OUT}$ ( $\Omega$ )
MAX1697R	12	10	17
MAX1697S	35	3.3	17
MAX1697T	125	1	17
MAX1697U	250	0.47	17

# 60mA, SOT23 Inverting Charge Pump with Shutdown

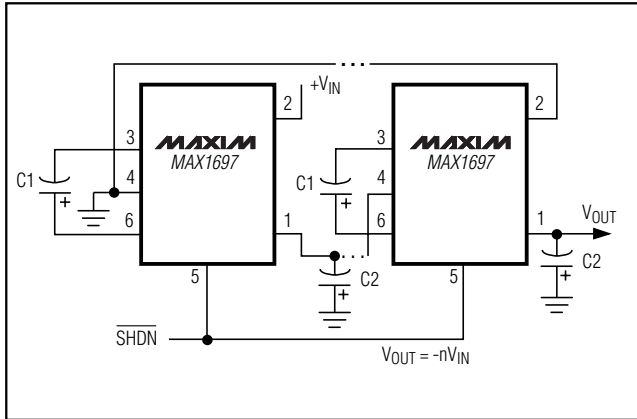

Figure 4. Cascading MAX1697s to Increase Output Voltage

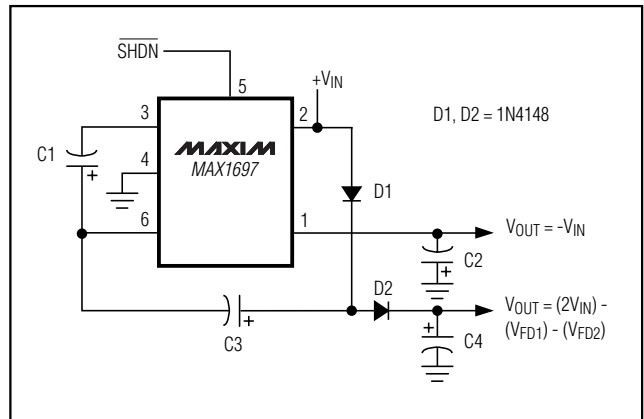

Figure 6. Combined Doubler and Inverter

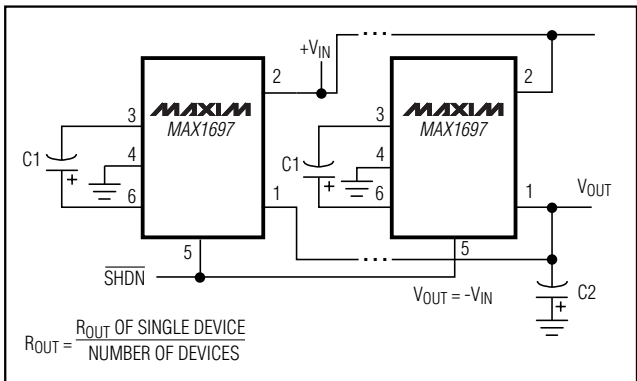

Figure 5. Paralleling MAX1697s to Reduce Output Resistance

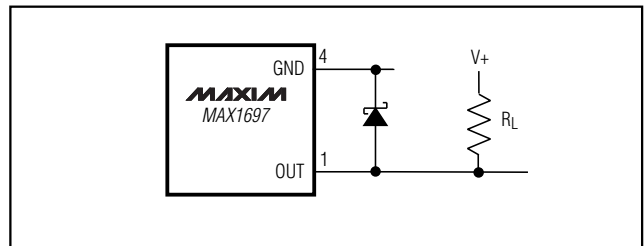

Figure 7. Heavy Load Connected to a Positive Supply

## Chip Information

TRANSISTOR COUNT: 275

# 60mA, SOT23 Inverting Charge Pump with Shutdown

## Package Information

**MAX1697**

6LSOT.EPS

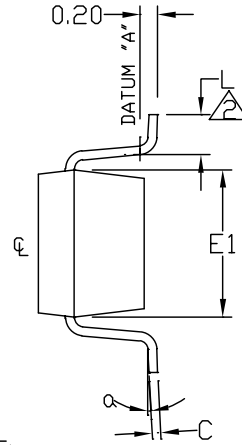
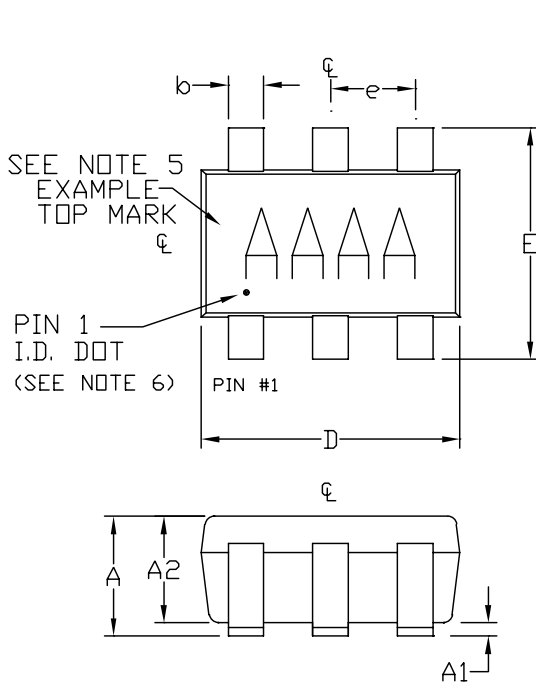

SYMBOL	MIN	MAX
A	0.90	1.45
A1	0.00	0.15
A2	0.90	1.30
b	0.35	0.50
C	0.08	0.20
D	2.80	3.00
E	2.60	3.00
E1	1.50	1.75
L	0.35	0.55
e	0.95 REF	
a	0°	10°

**NOTE:**

1. ALL DIMENSIONS ARE IN MILLIMETERS.
2. FOOT LENGTH MEASURED AT INTERCEPT POINT BETWEEN DATUM A & LEAD SURFACE.
3. PACKAGE OUTLINE EXCLUSIVE OF MOLD FLASH & METAL BURR.
4. PACKAGE OUTLINE INCLUSIVE OF SOLDER PLATING.
5. PIN 1 IS LOWER LEFT PIN WHEN READING TOP MARK FROM LEFT TO RIGHT. (SEE EXAMPLE TOP MARK)
6. PIN 1 I.D. DOT IS 0.3 MM Ø MIN. LOCATED ABOVE PIN 1.

<b>MAXIM</b>			
<small>PROPRIETARY INFORMATION</small>			
<small>TITLE:</small>			
PACKAGE OUTLINE, SOT23, 6L			
<small>APPROVAL</small>	<small>DOCUMENT CONTROL NO.</small>	<small>REV</small>	<small>1/1</small>
	21-0058	D	

Maxim cannot assume responsibility for use of any circuitry other than circuitry entirely embodied in a Maxim product. No circuit patent licenses are implied. Maxim reserves the right to change the circuitry and specifications without notice at any time.

**Maxim Integrated Products, 120 San Gabriel Drive, Sunnyvale, CA 94086 (408) 737-7600** \_\_\_\_\_ 11